

OL 90 N
 DE Zusatzverriegelung
 EN Additional locking device
 ES Enclavamiento adicional
 FR Verrouillage
 supplémentaire
 PL Blokada dodatkowa
 RU Дополнительное
 устройство запираения
 ZH 辅助锁止器

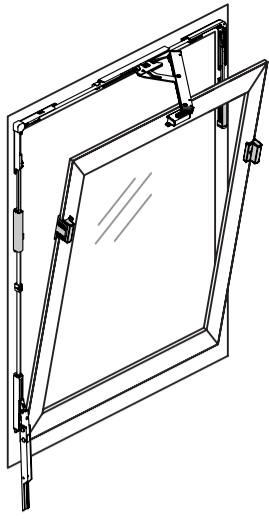

030459-06

GEZE



159976-..



www.geze.de

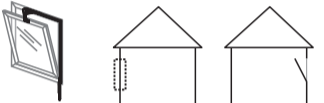
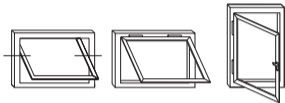
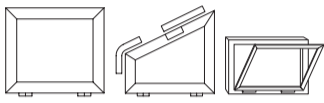

OL 90 N



030364 (OL 90 N)



OL 90 N



40444-EP-005



Ø 2,5 mm
 Ø 3,5 mm



4 x 35
 DIN 97 / DIN
 7997



min.
 1,8 mm



min. 2 x

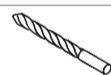

Ø 2,5 mm



Ø 3,5 mm



Ø 3,5 mm

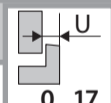

0...17

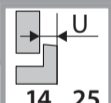

14...25

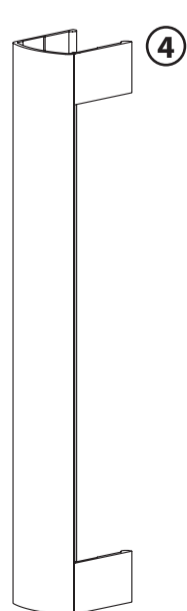
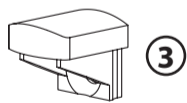
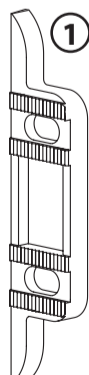
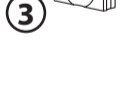
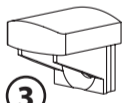
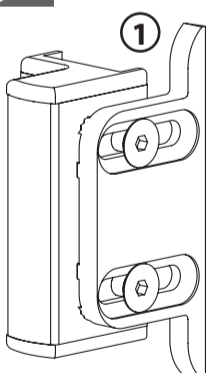

5

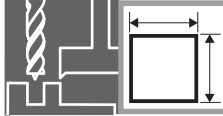

a min. = 580 mm
 b min. = 600 mm

D = 16 mm

OL 90 N	Fz 91	Fz 91	E212
X [mm]	26	25	30
		30	39

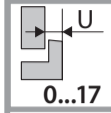

0...17

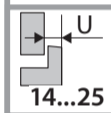
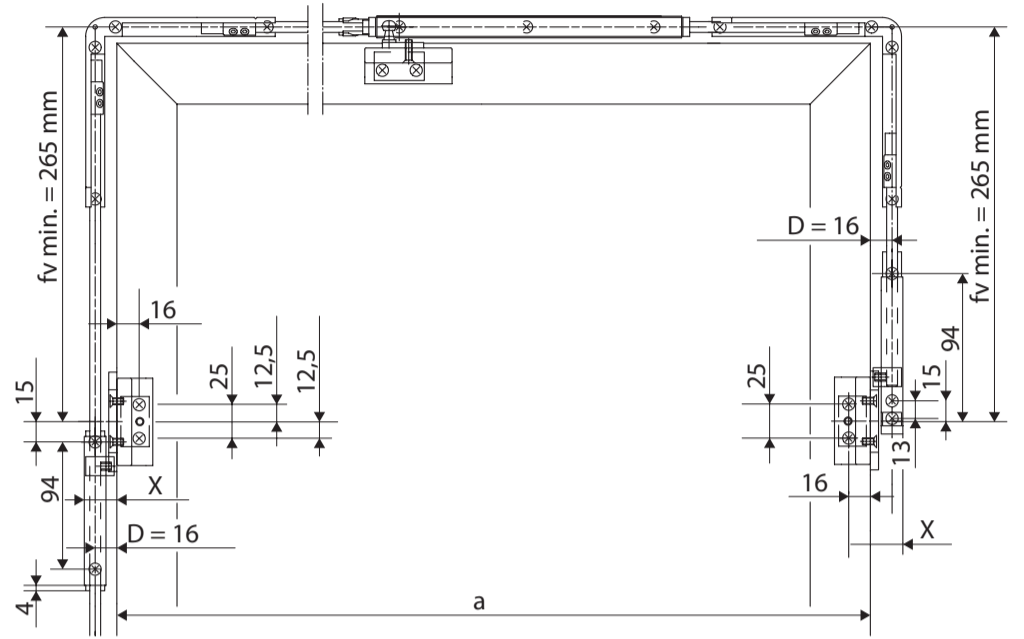

14...25

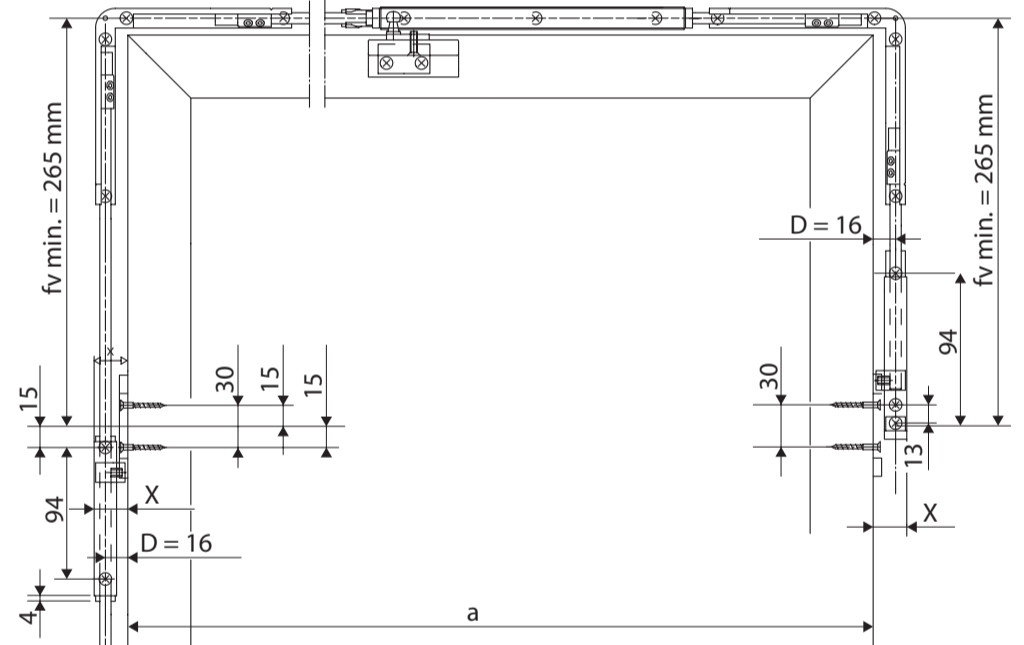

1

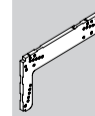

D = 16

ID

054800

054800

054799

F

32

32

45



F = 45

028141

